

*program*

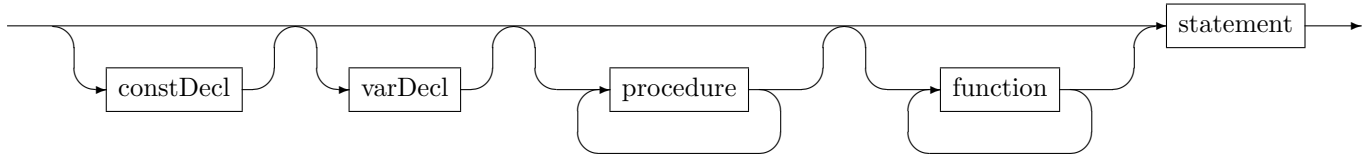

*constDecl*

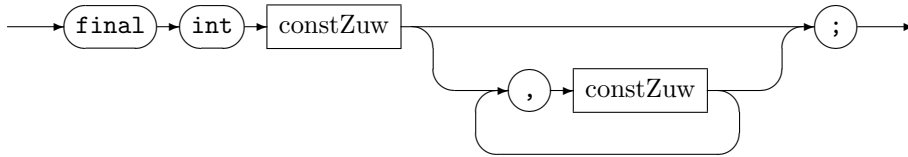

*constZuw*

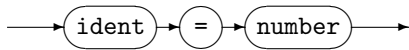

*varDecl*

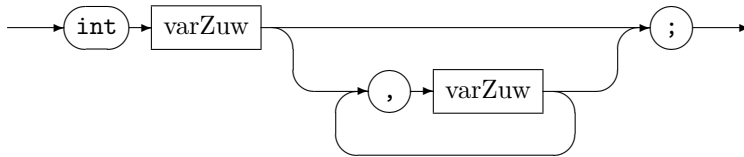

*varZuw*

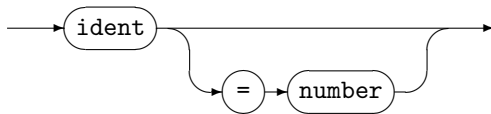

*procedure*

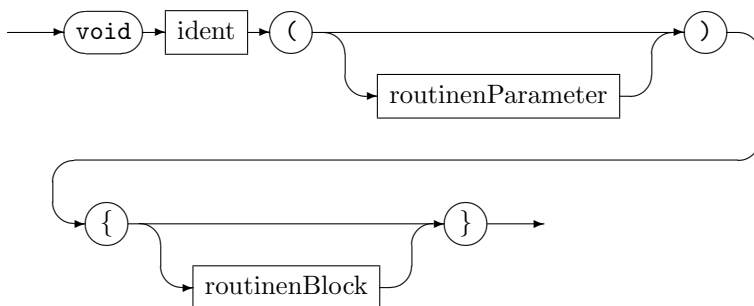

*function*

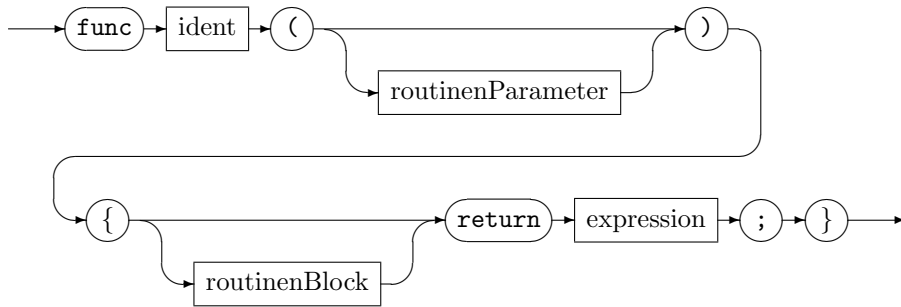

*routinenParameter*

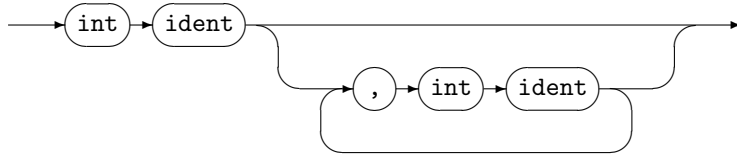

*routinenBlock*

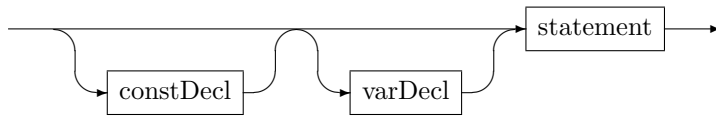

*expression*

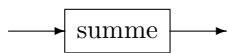

*summe*

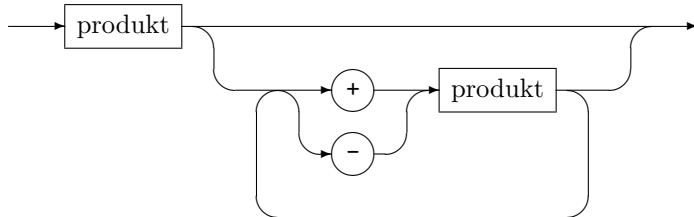

*produkt*

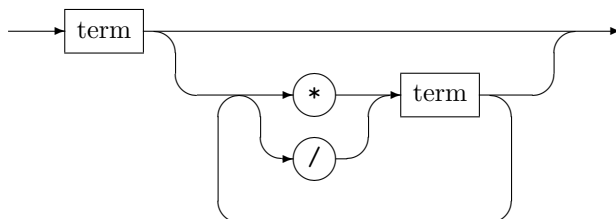

*term*

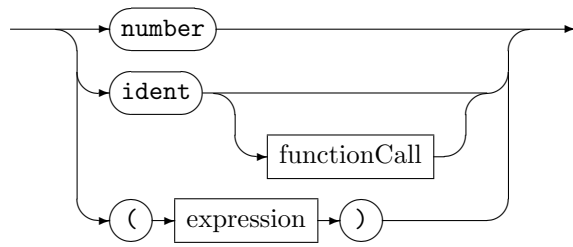

*condition*

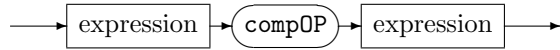

*functionCall*

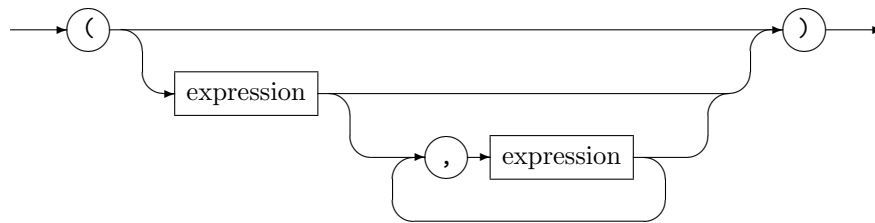

*procCall*

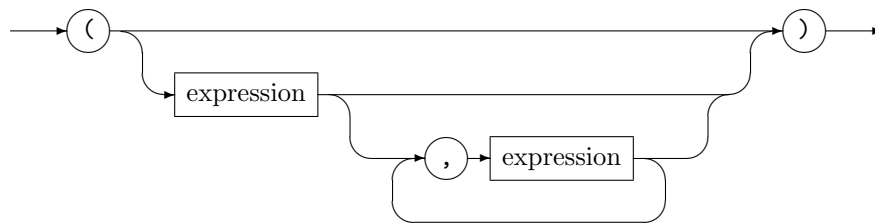

*statement*

